

Knife gate valve JTV

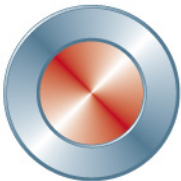
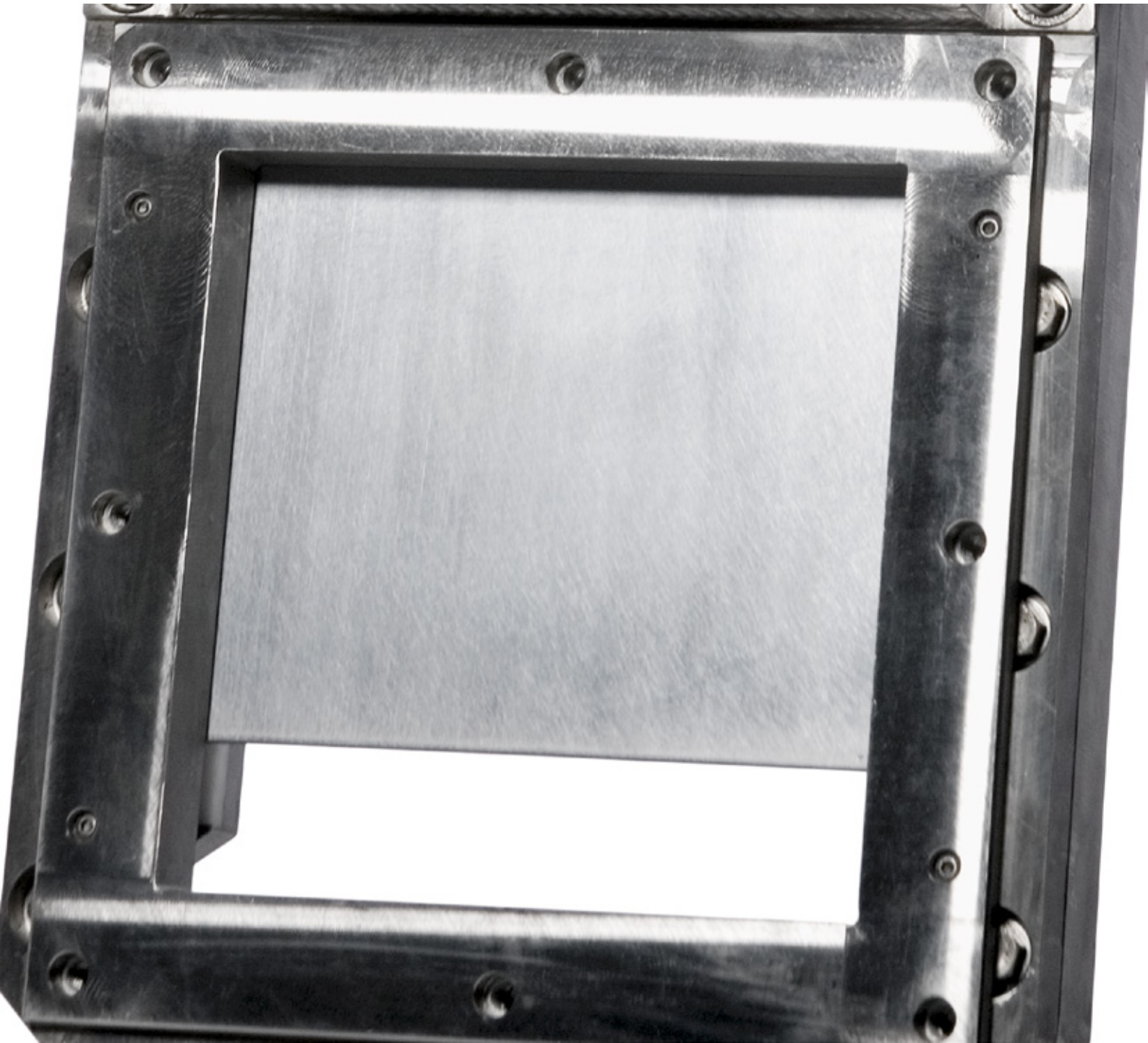

Stafsjö
SINCE 1666

Data is only for informational purpose. All specifications are subject to change without notice.

Knife gate valve JTV

Stafsjö's knife gate valve JTV is reliable and particularly well suited for demanding reject and other abrasive media. It is a part of Stafsjö's Junk Trap JT, which consist of a standard RKO valve on the inlet side and a JTV on the outlet side and a specially designed reject tank in between the two valves.

JTV has a two piece valve body in stainless steel with a square in- and outlet to counteract clogging and blockages. As standard the valve comes with a hard chromed gate in duplex stainless steel, polyurethane seat, exchangeable guiding pads and the retainer ring system which makes maintenance simple and cost-efficient. The gland-box is supplied with Stafsjö's unique gland box packing, TwinPack™, to secure that no media reaches the surrounding environment.

The top works consists of aluminium beams and stainless steel tie rods, which gives good corrosion resistance and a stable operation. There are several actuator types and accessories to choose from in Stafsjö's standard collection – all easily exchangeable between each other.

The JTV valve is designed, manufactured, inspected and tested according to the European Pressure Equipment Directive (PED 97/23/EC) category I and II module A1. The valve is CE marked when it is applicable.

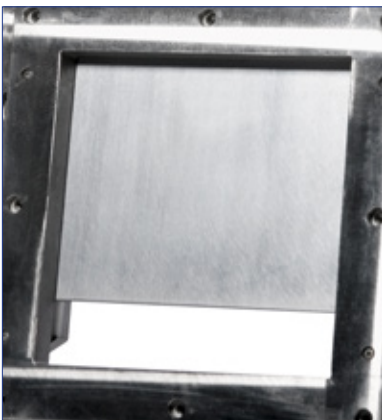

Proven design for reject applications

Upon closure the bevel edged gate cut off the media effectively and the square bore design assures a non-clogging shut-off.

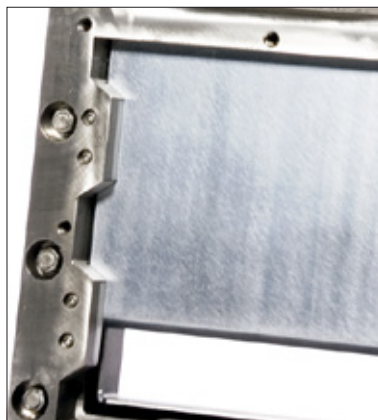

Easy maintenance lowers the life cycle cost

The JTV can easily be maintained to extend the service life. For example, Stafsjö's retainer ring that hold the seat in place is locked with screws just as the guiding pads are, making the parts extremely easy to change if needed.



A solid top works assures stability and a preserved sealing

A stable operation and a proper dimensioned top work makes the shut-off reliable and repeatable. It also minimizes wear on the equipment.

Design data

Size	Flange drilling	Face-to-face dimension	ATEX design
250 x 250	Stafsjö manufacturing standard	Stafsjö manufacturing standard	ATEX 94/ 9/EC II cat 3 G/D for zone 2 and 22 on request

Other sizes on request

Leakage rate	Pressure tests
EN 12266-1:2012 rate A: No visually detectable leakage is allowed for duration of the test	Pressure tests are performed with water at 20° C according to EN 12266-1:2012. Pressure shell test: 1,5 times maximum allowable working pressure for open valve. Pressure seat tightness test: 1,1 times maximum allowable differential pressure for closed valve.

Maximum working pressure body at 20°C		Maximum differential pressure in preferred direction at 20°C	
Size	bar	Size	bar
250 x 250	6	250 x 250	6

Basic equipment

A. Valve Body			
Material	Code	Type	Maximum temperature °C
Stainless steel	(E)	EN 1.4408	400

B. Gate		
Material	Type	Surface treatment
Stainless steel	EN 1.4462/S32205	Hard chrome

C. Retainer ring	
Material	Type
Stainless steel	EN 1.4408

D. Seat		
Material	Code	Maximum temperature °C
Polyurethane	(U)	90

E. Box packing		
Material	Code	Maximum temperature °C
TwinPack™	(TY)	260

Actuator

Double-acting pneumatic cylinder		
Size valve	Size EC	Force at 5 bar (kN)
250 x 250	200	14,1

JTV is equipped with pneumatic cylinder (EC). The table gives recommended cylinder sizes at normal operation at 5 bar air pressure. For other operating conditions, please contact Stafsjö or your local representative for advice.

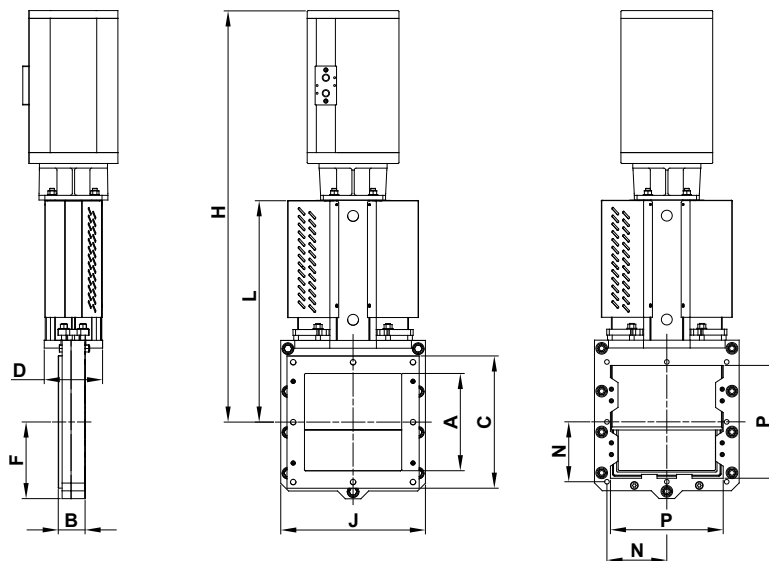

Main dimensions

Dimension (mm)										
Size	A	B	C	D	F	H	J	L	P	Weight ¹⁾
250 x 250	250	69	340	152	197	1057	372	570	290	80

Flange drilling (Stafsjö standard)				
Size	N	Tapped holes	Bolt size	Screw length
250 x 250	154	8	M12	18 ²⁾

¹⁾ Weight in kg for valve including pneumatic cylinder.

²⁾ Add the values with the thickness of the pipe flanges, the washers and thickness of the gasket.

Main dimensions are only for information. Contact Stafsjö for certified drawings.

Specify the Stafsjö valve

Stafsjö's valves are modular designed and they can easily be customized with gate, seat and box packings according to media and requirements, as well for actuators and accessories. Below are examples of how you can specify your Stafsjö valve. Further information is available on www.stafsjo.com.

JTV-E-250-U-TY-EC200-SS-ILS

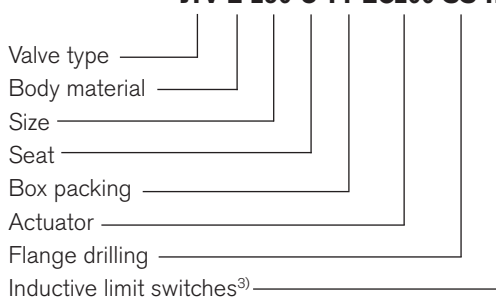

³⁾ All electronics must be specified in detail.

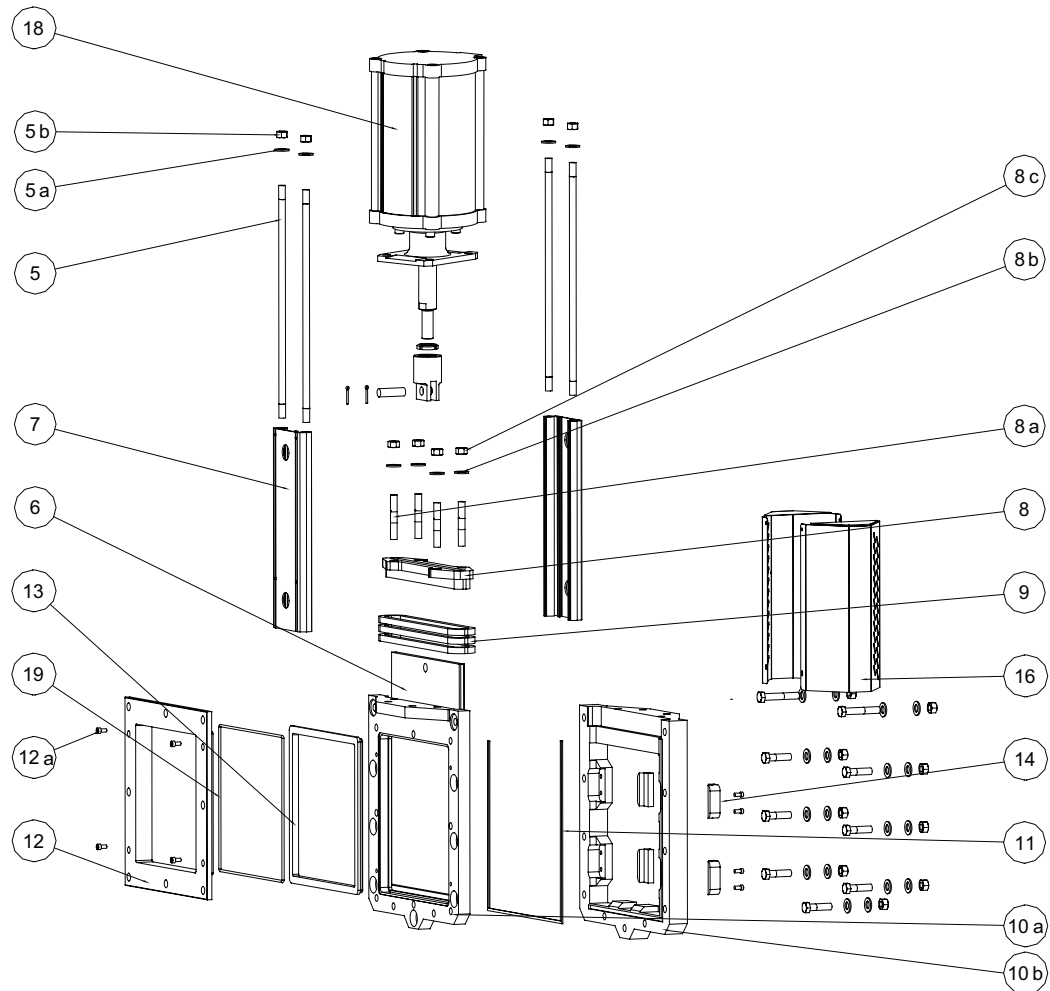

Part list

Pos	Part	Material (Name)
5	Tie rod	Stainless steel (EN 1.4301)
5 a	Washer	Stainless steel (A2)
5 b	Nut	Stainless steel (A2)
6	Gate	See basic equipment B
7	Beam	Aluminium (EN AW-6063-T6)
8	Gland	Stainless steel (EN 1.4408)
8 a	Stud bolt	Stainless steel (A2), zinc coated
8 b	Washer	Stainless steel (A2)
8 c	Nut	Stainless steel (A2), zinc coated
9 ⁴⁾	Box packing	See basic equipment E
10 a	Valve body	See basic equipment A

Pos	Part	Material (Name)
10 b	Valve body	See basic equipment A
11	Body gasket	PTFE
12	Retainer ring	See basic equipment C
12 a	Locking screw	Stainless steel (A2)
13 ⁴⁾	Seat	See basic equipment D
14 ⁴⁾	Guiding pads	POM-C
16	Gate guards	Stainless steel (EN 1.4301)
17	Gate clevis	Stainless steel (EN 1.4305)
18	Cylinder	See data sheet for EC
19 ⁴⁾	O-ring	Nitrile

⁴⁾ Recommended spare parts

Further information is available on www.stafsjo.com

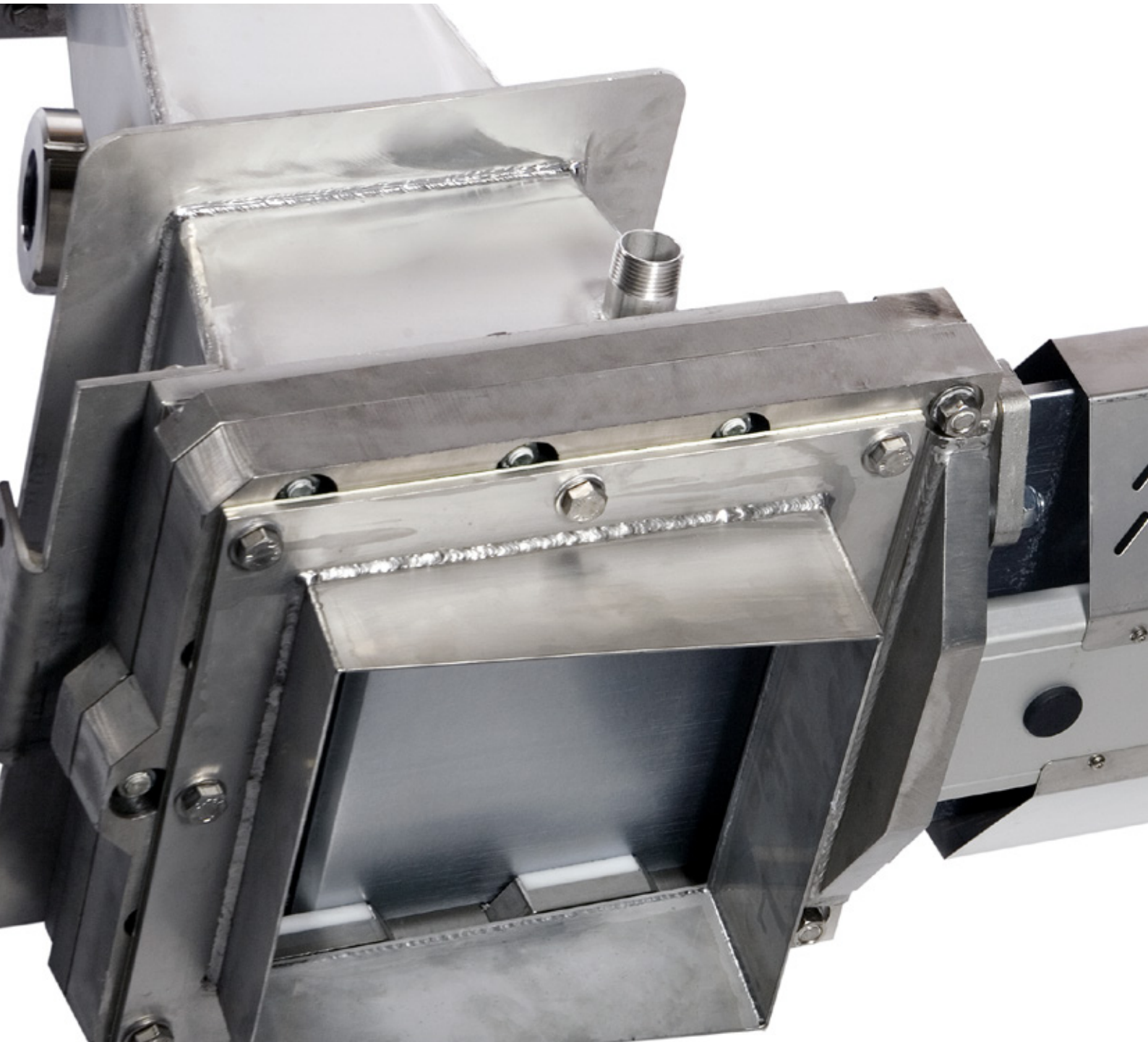

Globally active. Locally represented.

AFRICA South Africa: Valve & Automation (Pty) Ltd, ASIA China: EBRO ARMATUREN (BEIJING) CO., LTD, India: Ebro Armaturen India Pvt. Ltd, Indonesia: Contromatic Prima Mandiri PT, Japan: SKC Co. Ltd, Malaysia: Precision Control SdnBnd, Philippines: EBRO ARMATUREN (PHILIPPINES) INC., Thailand: EBRO VALVES (Trading) Co. Ltd., Vietnam: EBRO VALVES (Thailand) Co., Ltd, AUSTRALIA/OCEANIA Australia: EBRO ARMATUREN Pacific PTY. LTD, New Zealand: H.J.Asmuss&Co.Ltd EUROPE Austria: EBRO ARMATUREN GmbH, Belgium: V.C.T. - Valve & Connector Technology n.v., Denmark: Valtor Industri A/S, Finland: Tecalemit Flow Oy, France: EBRO ARMATUREN, Germany: EBRO ARMATUREN Gebr. Bröer GmbH, Great Britain: EBRO Valves Ltd, Hungary: EBRO ARMATUREN Kft, Ireland: ESI Technologies Ltd., Iceland: Hédinn HF, Italy: EBRO VALVOLE SRL, The Netherlands: EBRO VALVES B.V., Norway: BAGGES AS, Poland: EBRO ARMATUREN GmbH, Portugal: AxFlow Comércio de Equipamentos LDA, Russia: LesBumMash Ltd, Roitech and Sevkom, Spain: EBRO ARMATUREN ESPAÑA, S.L., Switzerland: EBRO Armaturen Est. & Co. KG, Sweden: Stafsjö Valves AB and Ahlsell Sverige AB, Turkey: EBRO ARMATUREN Otomasyon Sistemleri San ve Tic Ltd. Sti, Ukraine: EBRO ARMATUREN GmbH Representative office Kiev NORTH AMERICA Canada: Armour Valve Ltd, USA: EBRO ARMATUREN USA Inc. SOUTH AMERICA Argentina: ESCO ARGENTINA SA, Brazil: ELAN Equipamentos Industriais LTDA, Chile: Ebro Stafsjö Valves Chile Ltd For other countries, please contact us directly.

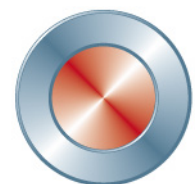

Stafsjö
SINCE 1666